

Valore 360° Auto-Rotate Wireless Selfie Stick (AC97)

VALORE

Thank you for purchasing the Valore 360° Auto-Rotate Wireless Selfie Stick (AC97)

- 360° Auto-rotate
- Built-in flash
- Built-in tripod
- Detachable shutter & control button

Important: Please read the user manual thoroughly before using your Wireless Selfie Stick.

Specifications:

- Wireless range: Up to 10m
- Battery capacity: 210mAh polymer
- Charging time: Approximately 2 hours
- Battery type: CR2032 (Remote control)
- Standby time: Up to 200 hours
- Working time: Up to 30 hours
- Power input: 5V
- Support: iOS/Android
- Pole extension: 25.8 – 102.2cm
- Clamp supports: Up to 6.6"
- Dimensions (L x W x H): 258 x 37.5 x 49mm

Package Contents:

- 360° Auto-rotate wireless selfie stick
- USB cable
- Remote control
- Pouch

UNDERSTANDING THE PRODUCT

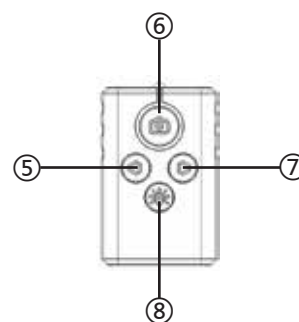
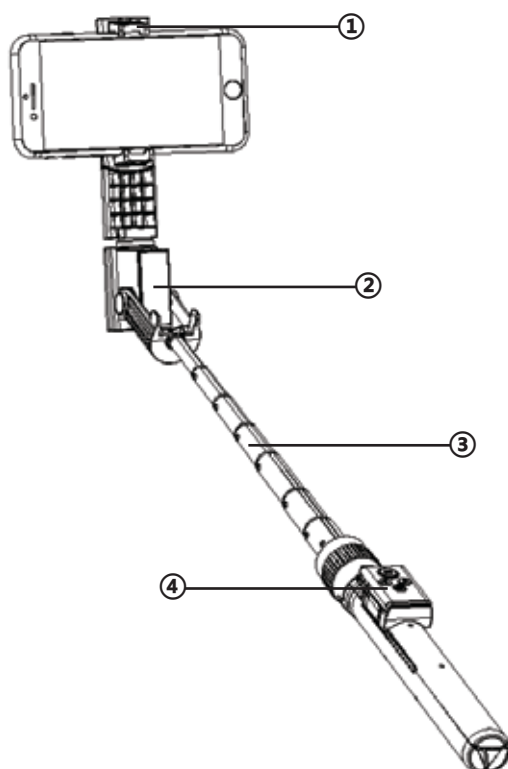

- ① Mobile holder
- ② LED light
- ③ Telescopic rod
- ④ Bluetooth remote control
- ⑤ Left rotation key
- ⑥ Shoot/Power switch
- ⑦ Right rotation key
- ⑧ LED light key

START USING SELFIE STICK

Remote control separation instructions

Step 1

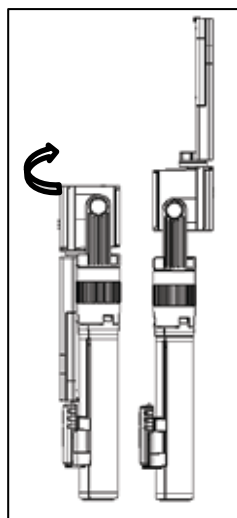

Open the mobile holder in the direction of the arrow illustrated in the picture. 180° with the selfie stick.

Step 2

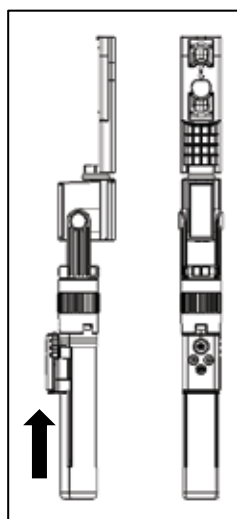

Slide the remote control together with the stand to suitable position.

Step 3

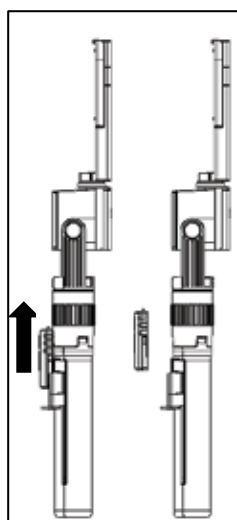

Hold the remote control stand, push the remote control up and remove the remote control from the stand.

Step 4

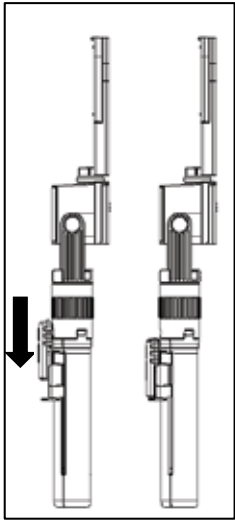

After use, hold the remote control stand, push down on the remote control and install it onto the stand.

Selfie stick operation instructions

Step 1

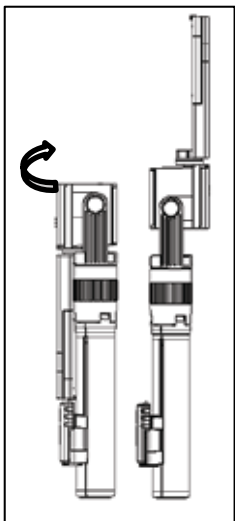

Open the mobile holder in the direction of the arrow illustrated in the picture. 180° with the selfie stick.

Step 2

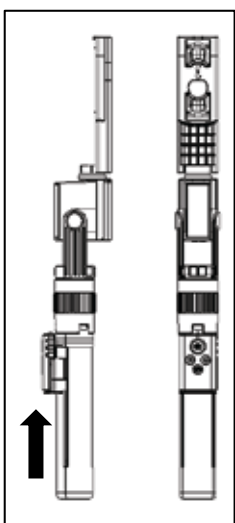

Slide the remote control together with the stand to suitable position.

Step 3

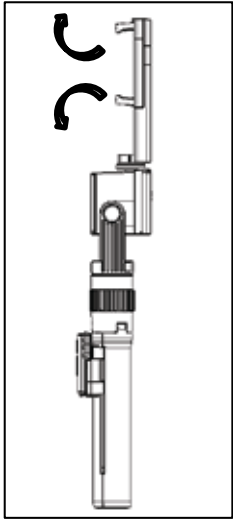

Open the bracket clip and slot mobile in.

Step 4

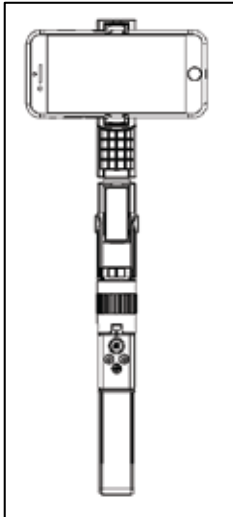

Step 5



Pull the telescopic rod to the required length



Step 6



Adjust the mobile holder to the right angle.

Step 7



Open the tripod handle on the bottom of the selfie stick to take a photo or take a video.

Step 8



Rotate the mobile holder to 90° with the selfie stick as indicated by the arrow in the illustration.

TECHNICAL SUPPORT & WARRANTY

- For Technical Support, email us at v.info@valore.sg.
- For Warranty Registration, visit www.valore.sg.

Cautions:

Read all the instructions and warnings carefully prior to using this product.

- Do not store the product in a high temperature environment.
- Do not place the product near a fire or other excessively hot environments.
- Do not expose the product to moisture or submerge it in liquid. Keep product dry at all times.
- Do not attempt to charge the product using any other method or connection other than the product's provided charging cable.
- Do not disassemble this product or attempt to repair or modify it in any manner.
- Battery usage by children should be supervised
- Be cautious of excessive drops, bumps, abrasions or other impacts to this product. If there is any damage to the product such as dents, punctures, tears, deformities or corrosion, stop using the product and contact us immediately via email at v.info@valore.sg, or return this product to the store where you have purchased it from.
- If the product produces an abnormal smell, high temperature (low temperature during normal use), discolours or changes shape abnormally, stop using the product and contact us immediately via email at v.info@valore.sg.

DISCLAIMER & TRADEMARKS

All information, trademarks, logos, graphics, and images ("Materials") provided on this user manual are copyrighted or trademarked and are the property of Valore Lifestyle Pte Ltd. Any unauthorized use of any material contained on the instruction manual may violate copyright laws, trademark laws, laws of privacy and communications statutes. The trademarks, service marks and logos used and displayed in the Materials are registered and unregistered trademarks and service marks of Valore and others. All other registered and unregistered company names, product names and marks mentioned herein the ("Materials") are the property of their respective owners and may be trademarks or registered trademarks.



Inspired by Valore Singapore

For full range of Valore products visit www.valore.sg