

Thank you for purchasing the Valore Smart Watch (VHA-21).

- Blood pressure monitor
- Heart rate monitor
- Customisable watch face
- Step, calorie & distance counter
- Sleep monitoring & exercise mode
- Call & alarm clock reminder
- Incoming call, text & app notification display^
- Multi-sports tracking, multi-watch face selection
- Female health assistant, weather information, sedentary reminder, hydration reminder

*^Please turn on all notification functions from mobile settings for notifications to show.*

**Important:** Please read the user manual thoroughly before using your Smart Watch.

### Specifications:

- Battery type: 90mAh Li-polymer
- Working time: Last up to 5 days
- Standby time: Up to 15 days
- Charging time: Approximately 2 hours
- Support: Android 4.4 and above  
iOS 8.2 and above
- Colour display screen size: 0.96"
- Language: Support multiple languages

### Package Contents:

- Smart watch x 1
- Charging cable
- Additional blue strap
- Additional wine red strap

## UNDERSTANDING THE PRODUCT



- ① Power button
- ② Watch face
- ③ Strap
- ④ Charging port (back)

# START USING SMART WATCH

## 1) Download AdorHealth app

Scan the qr code below to download and install the app client



Please scan code and download APP

## 2) Watch charging and activation

Charge the device to active before the first use.

To charge the device, plug the charging cable into adaptor or USB port on your computer.

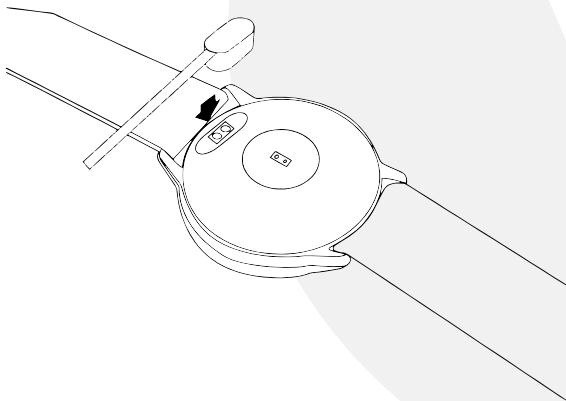

## 3) Bluetooth connection

1. Open the mobile location service and AdorHealth APP location

2. Open AdorHealth APP→Device→Add device→Search for Bluetooth and link

※ Do not connect Bluetooth via the background of phone. Be sure it is via APP search Bluetooth and link. If not, it will cause the Bluetooth of the watch to be occupied, the AdorHealth APP will not be able to search for the Bluetooth. At this time, the Bluetooth in the Phone's background must be ignored and released. Then Go back to the AdorHealth APP to search an connect.



There is a Red line in the Bottom right, which means that the watch's Bluetooth is not connected and occupied.



There is no red line in the Bottom right, which means the watch has been connected and occupied.

## 4) How to operate



## 5) Watch functions

### a) Using in Wet Conditions

Your device is water-resistant, which means it is rain-proof and splash-proof and can stand up to even the sweatiest workout.

**NOTE:** Do not swim with your Smart Bracelet.

We also don't recommend showering with your wristband; though the water won't hurt the device, wearing it 24/7 does not give your skin a chance to breathe. Whenever you get your bracelet wet, dry it thoroughly before putting it back on.

### b) Using Quick View

With Quick View you can check the time or the message from your phone on your Smart Watch without tapping. Just turn your wrist towards you and the time screen will appear for a few seconds.



## Sports Modes

Through the mobile APP, you can choose 18 sports modes at will, and up to 9 can be displayed. The watch will synchronously display the corresponding data such as heart rate, heat and speed allocation of movement when the movement is started. You can also pause or stop the movement.



## Sports Record

The sports ring tracks and records your steps, distance, and calories.

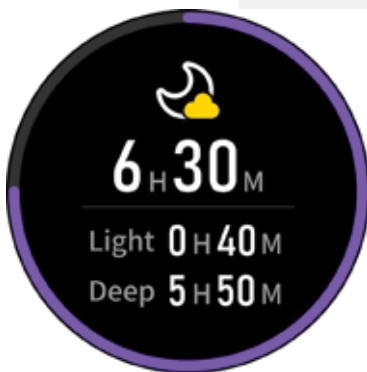

## Sleep Statistics

Enable sleep detection through the APP to automatically record sleep data, including total sleep time, deep sleep and light sleep time. More detailed information analysis and data records can be viewed in the APP.

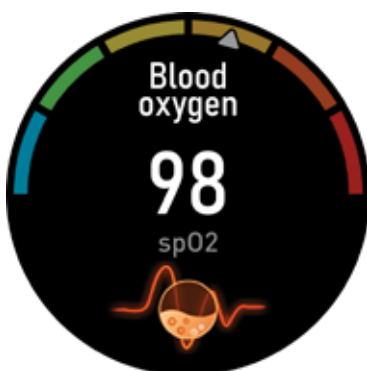

## Heart rate, blood pressure, oxygen

The heart rate, blood pressure and blood oxygen data can be independently detected through the Wrist Strap, and the watch can be set in the APP with an alarm of excessively high heart rate, which will be vibrated when the alarm heart rate is exceeded.



## Female health assistant

By open the menstrual prediction in the mobile APP, it's easier to keep track of your menstrual cycle, and the watch will remind you of the days from start of cycle.



## Mindfulness decompression

Breathing exercises can help you release stress effectively for two minutes five times a day. You can use the mobile APP to start a mindfulness decompression reminder period.



## Weather Information

The weather page displays current weather, air quality information, minimum and maximum temperatures, and slide one page to preview the weather over the next three days.

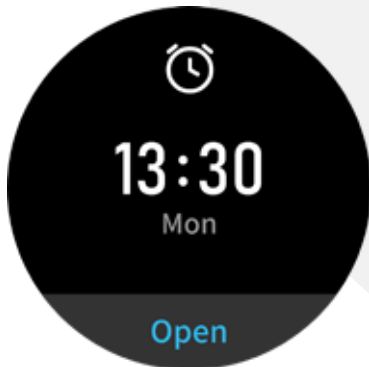

## Alarm

Through the APP, you can add and set the alarm time, synchronize the watch to display the alarm time, and turn the alarm on or off.

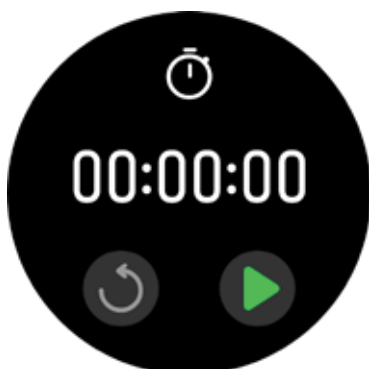

## Stopwatch

You can time, start or reset stopwatch.

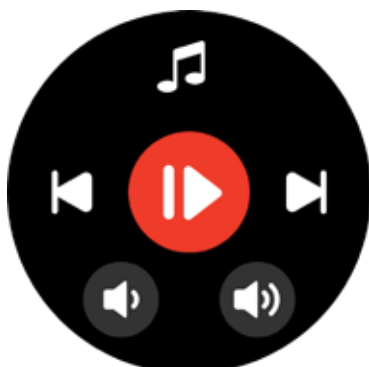

## Play Music

The watch can control music, switch the last and next song, play or pause music, and control volume.



## Look for mobile phone

Click on the icon of look for mobile phone to call a mobile phone.

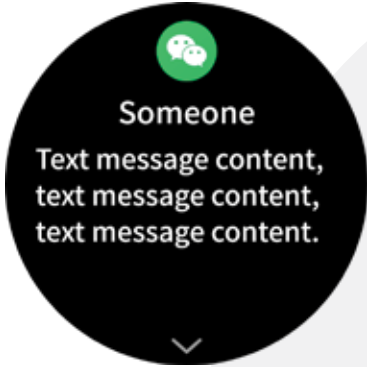

## Push message

The watch can receive and display notifications on the phone.

Open corresponding social applications that need to be pushed through the APP, and the watch message page can store up to 80 message records.



## Camera Control

After connecting the mobile phone, the watch can be used as a remote control for the mobile phone camera. After opening the mobile phone camera, click on the watch camera control page to trigger the mobile phone camera shutter. It also supports opening shake to take photos through the mobile APP.



## Settings

In watch settings, you can adjust the brightness, bright screen time, restore factory settings, restart, view the qr code of application.

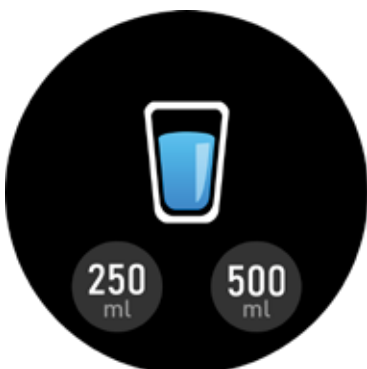

## Drinking Reminder

You can set your drinking goal and drinking time through the mobile APP, and the Wrist Strap will remind you to drink water in time to reach your daily goal.



## **Sedentary Reminder**

Enable the sedentary reminder through the mobile APP. You can set the reminder period, and the watch will remind you to get up and move on time.



## **Dial Settings**

Through the mobile APP, you can replace the massive dials at will, and you can also customize the Settings to edit photos and send them to the watch synchronously.



## **OTA Upgrade**

You can update the firmware through the mobile APP.

## TECHNICAL SUPPORT & WARRANTY

- For Technical Support, email us at [v.info@valore.sg](mailto:v.info@valore.sg).
- For Warranty Registration, visit [www.valore.sg](http://www.valore.sg).

### Cautions:

Read all the instructions and warnings carefully prior to using this product.

- Do not attempt to replace battery or open the enclosure or disassemble this product. Doing so will void the warranty and can result in safety hazard.
- Do not store the smart watch in a high temperature environment.
- Do not place the smart watch near a fire or other excessively hot environments.
- Do not expose this smart watch to moisture or submerge it in liquid. Keep smart watch dry at all times.
- Do not disassemble this smart watch or attempt to repair or modify it in any manner.
- Be cautious of excessive drops, bumps, abrasions or other impacts to this smart watch. If there is any damage to the smart watch such as dents, punctures, tears, deformities or corrosion, stop using the smart watch and contact us immediately via email at [v.info@valore.sg](mailto:v.info@valore.sg), or return this product to the store where you have purchased it from.
- If the product produces an abnormal smell, high temperature (low temperature during normal use), discolours or changes shape abnormally, stop using the product and contact us immediately via email at [v.info@valore.sg](mailto:v.info@valore.sg).

### DISCLAIMER & TRADEMARKS

All information, trademarks, logos, graphics, and images (“Materials”) provided on this user manual are copyrighted or trademarked and are the property of Challenger Technologies Limited. Any unauthorized use of any material contained on the instruction manual may violate copyright laws, trademark laws, laws of privacy and communications statutes.

The trademarks, service marks and logos used and displayed in the Materials are registered and unregistered trademarks and service marks of Valore and others. All other registered and unregistered company names, product names and marks mentioned herein the (“Materials”) are the property of their respective owners and may be trademarks or registered trademarks.

Complies with  
IMDA Standards  
DA103331



IOS is a trademark or registered trademark of Cisco in the U.S. and other countries and is used under license.

Inspired by Valore Singapore

For full range of Valore products visit [www.valore.sg](http://www.valore.sg)